



SWM280

v1.0



HARDWARE

FRONT VIEW

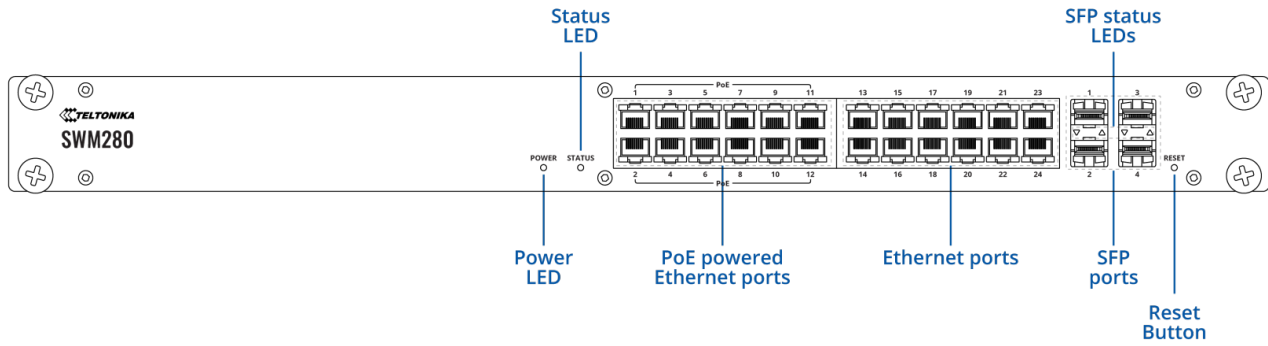

BACK VIEW

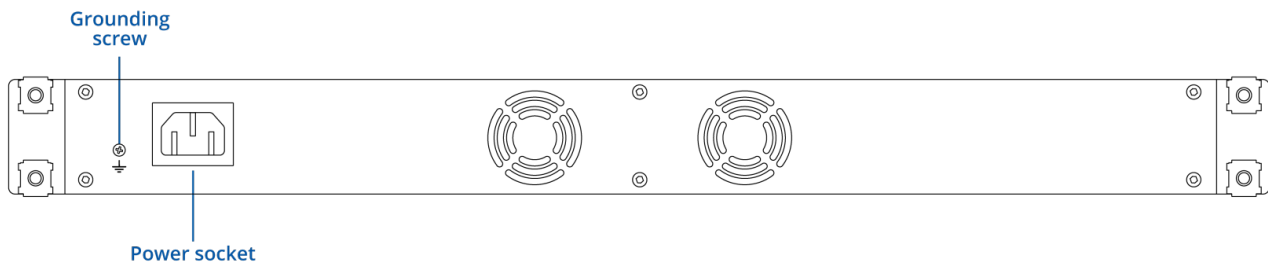

RJ45 LED meaning

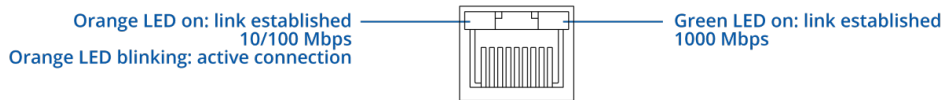

POWER SOCKET PINOUT

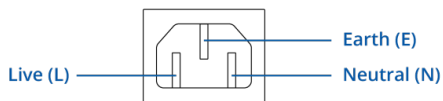

FEATURES

Ethernet

Fiber	4 x SFP ports
IEEE 802.3 series standards	802.3i, 802.3u, 802.3ab, 802.3x, 802.3z
ETH	Multi-layer managed 24 x ETH ports, 10/100/1000 Mbps, supports auto MDI/MDIX crossover

INDUSTRIAL PROTOCOLS

Profinet	Profinet Class B conformance (available with optional order code)
-----------------	---

Services

EtherNet/IP	Yes
SNMP V2, V3	Yes
LLDP	Yes
Network Management	802.1p class of service, 802.1x port-based network access control, 802.1Q VLAN

Network

Routing	Dynamic routing (BGP, OSPF v2, RIP v1/v2, EIGRP)
MRP	MRP client role, MRP manager role
L2 features	Loop protection, Forwarding table, VLAN, STP/RSTP
DHCP	DHCP server, DHCP client, DHCP static leases capable of using MAC with wildcards
Port Settings	Enable/disable, link speed control, port isolation, PoE Management, EEE (802.3az) management, Port Mirroring
L3 Features	Static IPv4 routing, static IPv6 routing, DHCPv6 client, static IPv6 address

QoS

QOS	Port priority, DSCP priority, 802.1p priority, TOS
Scheduling method	SP/WFQ/WRR
Bandwidth control	Rate limiting, storm control
Traffic Shaper	Port-based shaping

Diagnostics

Tools	Cable diagnostic, ping, traceroute, nslookup
Ping reboot	Capability to restart PoE in a specific port

Security

Authentication	PAM — preshared key, Radius & TACACS+, IP & login attempts block
VLAN	Port VLAN separation
TPM	Identification and authentication module, TPM 2.0 standard
802.1x	Port-based network access control client and server
MAC filtering support	Enable MAC filtering functionality to control access to the TSW. This feature allows users to permit or deny specific devices from communicating through the TSW by entering their MAC addresses

API

Teltonika Networks Web API (beta) support	Expand your device's possibilities by using a set of configurable API endpoints to retrieve or change data. For more information, please refer to this documentation: https://developers.teltonika-networks.com
--	---

System Characteristics

CPU	Realtek, single core, 500MHz, MIPS-4KEc
RAM	128MB, DDR3
FLASH storage	16 MB serial flash

Firmware / Configuration

WEB UI	Update FW from file, check FW on server, configuration profiles, configuration backup
FOTA	Update FW
RMS	Update FW/configuration for multiple devices at once
Keep settings	Update FW without losing current configuration
Factory settings reset	A full factory reset restores all system settings, including the IP address, PIN, and user data to the default manufacturer's configuration

FIRMWARE CUSTOMISATION

Operating system	TSWOS (OpenWrt based Linux OS)
Supported languages	Busybox shell, Lua, C, C++
Development tools	SDK package with build environment provided
Package Manager	The Package Manager is a service used to install additional software on the device

Performance Specifications

Bandwidth (Non-blocking)	56 Gbps
Forwarding rate	83.33 Mpps
Packet buffer	512 KB
MAC address table size	8K entries
Jumbo frame support	10000 bytes

POE OUT

PoE ports	Port 1-12
PoE standards	802.3af and 802.3at Alternative A
PoE Max Power per Port (at PSE)	30 W
Total PoE Power Budget (at PSE)	300 W

Power

Connector	C14 connector
Input voltage range	100-240 VAC, 50/60 Hz
Power consumption	Idle: 7.5 W / Max: 325 W / PoE Max: 300

Physical Interfaces

Ethernet	24 x RJ45 ports, 10/100/1000 Mbps
Fiber	4 x SFP ports
Status LEDs	1 x Power LED, 48 x ETH status LEDs, 1 x Status LED, 4 x SFP status LEDs
Power	1 x C14 connector
Reset	Software reset button
Other	1 x Grounding screw

Physical Specification

Casing material	Anodized aluminum housing and panels
Dimensions (W x H x D)	483 x 44 x 234 mm
Weight	1770 g
Mounting options	Rack mounting kit

Operating Environment

Operating temperature	0 °C to 50 °C
Operating humidity	10% to 90% non-condensing
Ingress Protection Rating	IP30

Regulatory & Type Approvals

Regulatory	CE, UKCA, CB, RCM, FCC, IC
-------------------	----------------------------

ORDERING

STANDARD PACKAGE*



- SWM280 L2+ managed switch
- QSG (Quick Start Guide)
- Packaging box

*Standard package contents may differ based on standard order codes.

For more information on all available packaging options – please [contact us](#) directly.

CLASSIFICATION CODES

HS Code: 851762

HTS: 8517.62.00

AVAILABLE VERSIONS

SWM280 *****0	N/A	SWM280000000 / Standard package
PROFINET disabled by default		
SWM280 *****1	N/A	SWM280000001 / Standard package
Profinet Class B conformance		

For more information on all available packaging options – please [contact us](#) directly.

SWM280 SPATIAL MEASUREMENTS

TOP VIEW

The figure below depicts the measurements of device and its components as seen from the top:

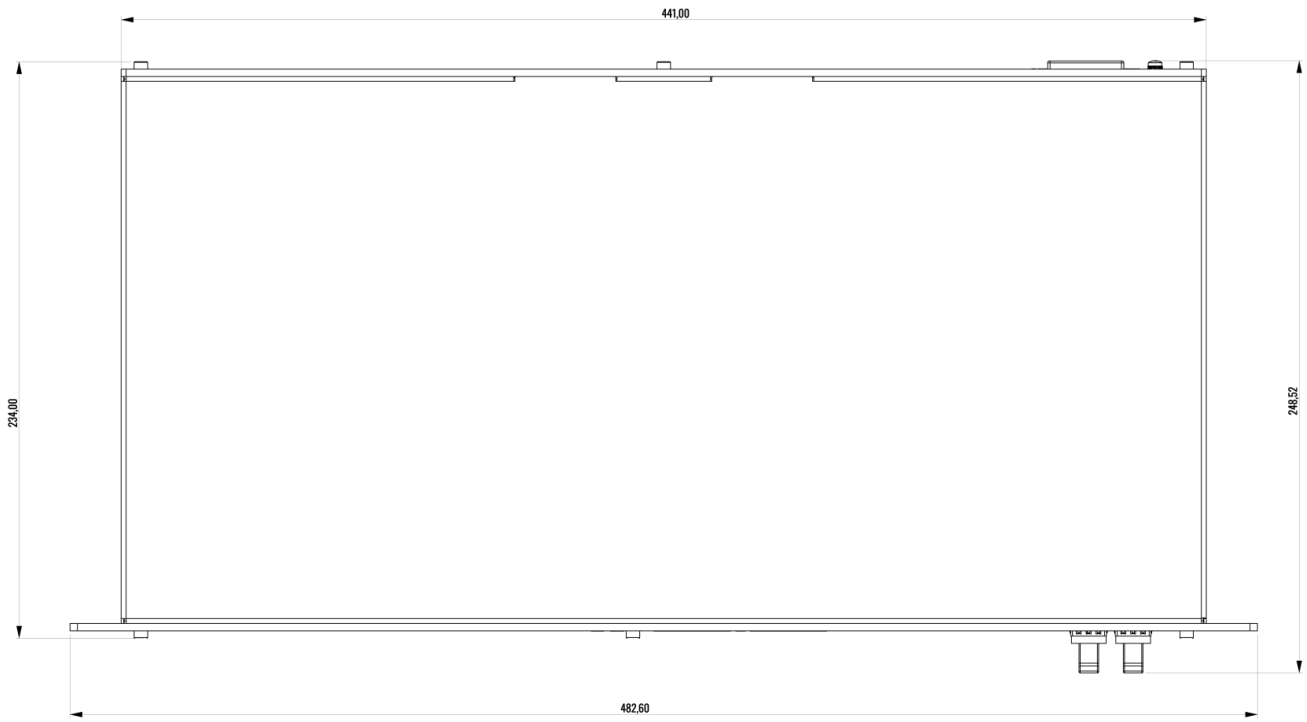

RIGHT VIEW

The figure below depicts the measurements of device and its components as seen from the right:

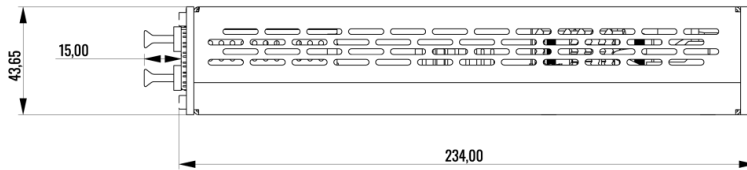

REAR VIEW

The figure below depicts the measurements of device and its components as seen from the back panel side:

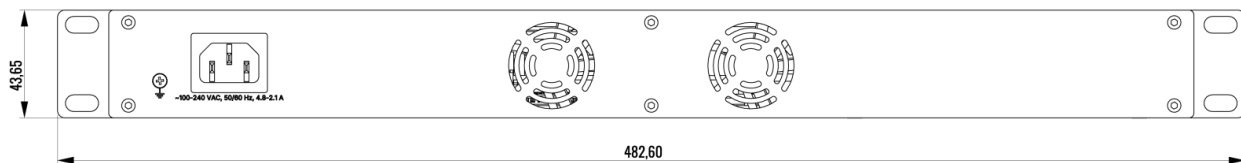

FRONT VIEW

The figure below depicts the measurements of device and its components as seen from the front panel side:

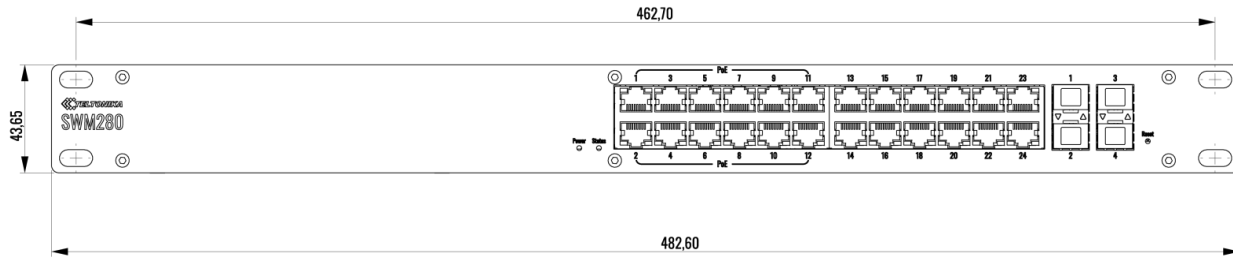
MOUNTING SPACE REQUIREMENTS

The figure below depicts an approximation of the device's dimensions when cables and antennas are attached:

